

**Worcester County Administration  
1 West Market Street, Room 1103  
Snow Hill, Maryland 21863**



**INVITATION FOR BID**

**PROJECT:** South Point Bulkhead Replacement Phase II

**DEPARTMENT:** Recreation and Parks

**VENDOR:**

**NAME:** \_\_\_\_\_

**ADDRESS:** \_\_\_\_\_  
\_\_\_\_\_

**BID OPENING:**

**DATE:** Monday, September 18, 2023

**TIME:** 2:30pm

# TABLE OF CONTENTS

<b>SECTION I: INTRODUCTION</b> .....	3
A. <b>PURPOSE</b> .....	3
B. <b>CLARIFICATION OF TERMS</b> .....	3
C. <b>QUESTIONS AND INQUIRES</b> .....	3
D. <b>FILLING OUT BID DOCUMENTS</b> .....	3
E. <b>SUBMISSION OF BID DOCUMENTS</b> .....	4
F. <b>OPENING OF BIDS</b> .....	4
G. <b>ACCEPTANCE OR REJECTION OF BIDS</b> .....	4
H. <b>QUALIFICATIONS</b> .....	5
I. <b>DESCRIPTIVE LITERATURE</b> .....	5
J. <b>NOTICE TO VENDORS</b> .....	6
K. <b>PIGGYBACKING</b> .....	6
<b>SECTION II: GENERAL INFORMATION</b> .....	7
A. <b>ECONOMY OF BID</b> .....	7
B. <b>PUBLIC INFORMATION ACT (PIA)</b> .....	7
C. <b>CONTRACT AWARD</b> .....	7
D. <b>AUDIT</b> .....	7
E. <b>NONPERFORMANCE</b> .....	7
F. <b>MODIFICATION OR WITHDRAWAL OF BID</b> .....	8
G. <b>DEFAULT</b> .....	8
H. <b>COLLUSION/FINANCIAL BENEFIT</b> .....	8
I. <b>TAX EXEMPTION</b> .....	8
J. <b>CONTRACT CHANGES</b> .....	9
K. <b>ADDENDUM</b> .....	9
L. <b>EXCEPTIONS/ SUBSTITUTIONS</b> .....	9
M. <b>APPROVED EQUALS</b> .....	10
N. <b>DELIVERY</b> .....	10
O. <b>INSURANCE</b> .....	10
P. <b>BID EVALUATION</b> .....	10
<b>SECTION III: GENERAL CONDITIONS</b> .....	11
A. <b>DRAWINGS AND SPECIFICATIONS</b> .....	11
B. <b>MATERIALS, SERVICES AND FACILITIES</b> .....	11
C. <b>INSPECTION AND TESTING</b> .....	11
D. <b>APPROVAL OF SUBSTITUTION OF MATERIALS</b> .....	12
E. <b>PROTECTION OF WORK, PROPERTY AND PERSONS</b> .....	12
F. <b>BARRICADES, DANGER, WARNING AND DETOUR SIGNS</b> .....	12
G. <b>LICENSES AND PERMITS</b> .....	12
H. <b>SUPERVISION</b> .....	13
I. <b>CLEAN UP</b> .....	13
J. <b>CHANGES IN WORK</b> .....	13
K. <b>TIME FOR COMPLETION</b> .....	13
L. <b>LIQUIDATED DAMAGES</b> .....	14
M. <b>CORRECTION OF WORK</b> .....	14
N. <b>CONSTRUCTION SAFETY AND HEALTH STANDARDS</b> .....	14
O. <b>BID BOND</b> .....	14
P. <b>PERFORMANCE AND PAYMENT BONDS</b> .....	15
Q. <b>GUARANTEE</b> .....	15
<b>SECTION IV: BID SPECIFICATIONS</b> .....	16
A. <b>SCOPE</b> .....	16
B. <b>CONTRACT PRICING</b> .....	16
C. <b>SUMMARY</b> .....	16
D. <b>METHOD OF WORK</b> .....	16
E. <b>GENERAL REQUIREMENTS</b> .....	16
F. <b>PRE-BID CONFERENCE</b> .....	16
G. <b>ATTACHMENTS</b> .....	16
H. <b>PAYMENT</b> .....	16
I. <b>QUESTIONS</b> .....	17
J. <b>AWARD</b> .....	17
<b>FORM OF BID</b> .....	18
<b>REFERENCES</b> .....	19
<b>EXCEPTIONS</b> .....	20
<b>INDIVIDUAL PRINCIPAL</b> .....	21
<b>VENDOR'S AFFIDAVIT OF QUALIFICATION TO BID</b> .....	22
<b>NON-COLLUSIVE AFFIDAVIT</b> .....	23
<b>EXHIBIT A</b> .....	24

## SECTION I: INTRODUCTION

### A. PURPOSE

1. The purpose of this Invitation for Bid Document is for Worcester County (“County”) to contract for the replacement of approximately 295 linear feet of existing timber bulkhead with a new vinyl sheet bulkhead system, including new tieback system in conformity with the requirements contained herein (“Bid Document(s”).

### B. CLARIFICATION OF TERMS

1. Firms or individuals that submit a bid for award of a contract (“Contract”) are referred to as vendors (“Vendors”) in this document. The Vendor that is awarded the Contract is herein referred to as the (“Successful Vendor”).

### C. QUESTIONS AND INQUIRES

1. Questions must be addressed in writing to the Worcester County Procurement Officer at [nrice@co.worcester.md.us](mailto:nrice@co.worcester.md.us).
2. The last date to submit questions for clarification will be **noon on Monday, September 11, 2023**.
3. Addenda are posted on the County website at <https://www.co.worcester.md.us/> under County Info: Bid Board: at <https://www.co.worcester.md.us/commissioners/bids> at least five calendar days before bid opening.
4. It is the Vendors responsibly to make sure all addenda are acknowledged in their bid. Failure to do so could result in the bid being disqualified.

### D. FILLING OUT BID DOCUMENTS

1. Use only forms supplied by the County.
2. One unbound original and two bound copies of the bid form and any required attachments must be submitted in the solicitation and can be submitted in the same envelope unless otherwise instructed.
3. Bid Documents should be compiled as follows: (1) Cover letter, (2) Form of Bid, (3) References, (4) Exceptions Document and Signed addenda, if necessary (5) Individual Principal Document, (6) Vendor’s Affidavit of Qualification to Bid, and (7) Non-Collusive Affidavit
4. Where so indicated by the make-up of the Bid Documents, sums will be expressed in both words and figures, and in the case of a discrepancy between the two, the amount written in words will govern. In the event there is a discrepancy between the unit price and the extended totals, the unit prices will govern.
5. Any interlineation, alteration, or erasure will be initialed by the signer of the Bid Documents.
6. Each copy of the Bid Documents will be signed by the person(s) legally authorized to bind the Vendor to a contract, using the legal name of the signer. Bid Documents submitted by an agent will have a current Power of Attorney attached certifying the agent’s authority to bind the Vendor.
7. Vendor will supply all information and submittals required by the Bid Documents to constitute a proper and responsible completed Bid Document package.
8. Any ambiguity in the Bid Documents as a result of omission, error, lack of clarity or non-compliance by the Vendor with specifications, instructions, and/or all conditions of bidding will be construed in the light most favorable to the County.

**E. SUBMISSION OF BID DOCUMENTS**

1. All copies of the Bid Documents and any other documents required to be submitted with the Bid Documents will be enclosed in a sealed envelope. The envelope will be addressed to the Worcester County Commissioners and will be identified with the project name: **SOUTH POINT BULKHEAD REPLACEMENT PHASE II** and the Vendor's name and address. If the Bid Documents are sent by mail, the sealed envelope will be enclosed in a separate mailing envelope with the notation "SEALED BID DOCUMENTS ENCLOSED" on the face thereof.
2. Bids must be mailed or hand carried to the **Worcester County Administration Office, 1 West Market Street, Room 1103, Snow Hill, MD 21863**, in order to be received **prior** to the announced bid deadline. *Bids received after said time or delivered to the wrong location will be returned to the Vendor unopened.*
3. **Bids are due and will be opened at the time listed on the front of this Bid Document.**
4. If you are delivering a bid in person please keep in mind to allow time to get through security and into the Administration Office. It is fully the responsibility of the Vendor to ensure that the bid is received on time.
5. The County will not speculate as to reasonableness of the postmark, nor comment on the apparent failure of a public carrier to have made prompt delivery of the bid.
6. Vendors, or their authorized agents, are expected to fully inform themselves as to the conditions, requirements, and specifications before submitting Bid Documents; failure to do so will be at the Vendor's own risk.
7. A fully executed Affidavit of Qualification to Bid will be attached to each Bid Document.
8. Minority vendors are encouraged to participate.
9. All Vendor submitted Bid Documents will be valid for a minimum of sixty days from the date of Bid Document opening.
10. Electronically mailed bids are **not** considered sealed bids and will **not** be accepted.

**F. OPENING OF BIDS**

1. Bid Documents received on time will be opened publicly and Vendor's names and total costs will be read aloud for the record.
2. The Contract will be awarded or all Bid Documents will be rejected within sixty days from the date of the Bid Document opening.

**G. ACCEPTANCE OR REJECTION OF BIDS**

1. Unless otherwise specified, the Contract will be awarded to the most responsible and responsive Vendor complying with the provisions of the Bid Documents, provided the bid does not exceed the funds available, and it is in the best interest of the County to accept it. The County reserves the right to reject the Bid Documents of any Vendor who has previously failed to perform properly in any way or complete on time contracts of a similar nature; or a Bid Document from a Vendor who, investigation shows, is not in a position to perform the Contract; or Bid Documents from any person, firm, or corporation which is in arrears or in default to the County for any debt or contract.
2. Completed Bid Documents from Vendors debarred from doing business with the State of Maryland or the Federal Government will not be accepted.
3. In determining a Vendor's responsibility, the County may consider the following qualifications, in addition to price:

- a. Ability, capacity, and skill to provide the commodities or services required within the specified time, including future maintenance and service, and including current financial statement or other evidence of pecuniary resources and necessary facilities.
  - b. Character, integrity, reputation, experience and efficiency.
  - c. Quality of past performance on previous or existing contracts, including a list of current and past contracts and other evidence of performance ability.
  - d. Previous and existing compliance with laws and ordinances relating to contracts with the County and to the Vendor's employment practices.
  - e. Evidence of adequate insurance to comply with Contract terms and conditions.
  - f. Statement of current work load and capacity to perform/provide the Goods and/or Services.
  - g. Explanation of methods to be used in fulfilling the Contract.
  - h. The Vendor, if requested, will be prepared to supply evidence of its qualifications, listed above, and its capacity to provide/perform the Goods and/or Services; such evidence to be supplied within a specified time and to the satisfaction of the County.
4. In determining a Vendor's responsiveness, the County will consider whether the Bid Document conforms in all material respects to the Bid Documents. The County reserves the right to waive any irregularities that may be in its best interest to do so.
  5. The County will have the right to reject any and all Bid Documents, where applicable to accept in whole or in part, to add or delete quantities, to waive any informalities or irregularities in the Bid Document received, to reject a Bid Document not accompanied by required Bid security or other data required by the Bid Documents, and to accept or reject any Bid Document which deviates from specifications when in the best interest of the County. Irrespective of any of the foregoing, the County will have the right to award the Contract in its own best interests.

#### **H. QUALIFICATIONS**

1. The Vendor must be in compliance with the laws regarding conducting business in the State of Maryland.

All Vendors shall provide a copy Certificate of Status from the Maryland Department of Assessments and Taxation, evidencing the Vendor is in good standing with the State of Maryland. See [https://sdatcert1.resiusa.org/certificate\\_net/](https://sdatcert1.resiusa.org/certificate_net/) for information on obtaining the Certificate of Status. *Certificates of status are not available for trade names, name reservations, government agencies, sole proprietorships, and some other accounts as these are not legal entities and thus are not required for these categories of Vendors.* For more information on the Certificate of Status please see <http://www.dat.state.md.us/sdatweb/COSinfo.html> .

2. Worcester County reserves the right, at its sole discretion, to extend the date this documentation must be provided. The Vendor's inability to provide this documentation could result in the bid being rejected.

#### **I. DESCRIPTIVE LITERATURE**

1. The proposed descriptive literature fully describing the product bid is what is intended to be included as the price. Failure to do so may be cause for rejection of the bid.
2. Any items, systems or devices supplied in this bid that are proprietary in nature relative to maintenance, repair, servicing or updating must be disclosed on the bid form.

**J. NOTICE TO VENDORS**

1. Before a Vendor submits the Bid Documents it will need to become fully informed as to the extent and character of the Goods and/or Services required and are expected to completely familiarize themselves with the requirements of this Bid Document's specifications. Failure to do so will not relieve the Vendor of the responsibility to fully perform in accordance therewith. No consideration will be granted for any alleged misunderstanding of the material to be furnished or the Services to be performed, it being understood that the submission of a Bid Document is an agreement with all of the items and conditions referred to herein.

**K. PIGGYBACKING**

1. Worcester County may authorize, upon request, any governmental entity (hereafter Authorized User) within the County to purchase items under the contract awarded pursuant to this bid solicitation.
2. All purchase orders issued against the contract by an authorized User shall be honored by the Successful Vendor in accordance with all terms and conditions of this contract.
3. The issuance of a purchase order by an Authorized User pursuant to this provision shall constitute an express assumption of all contractual obligations, covenants, conditions and terms of the contract. A breach of the contract by any particular Authorized User shall neither constitute nor be deemed a breach of the contract as a whole which shall remain in full force and effect, and shall not affect the validity of the contract nor the obligations of the Successful Vendor thereunder respecting the County.
4. The County specifically and expressly disclaims any and all liability for any breach by an Authorized User other than the County and each such Authorized User and Successful Vendor guarantee to save the County, its officers, agents and employees harmless from any liability that may be or is imposed by the Authorized User's failure to perform in accordance with its obligations under the contract.

**END OF SECTION**

## **SECTION II: GENERAL INFORMATION**

### **A. ECONOMY OF BID**

1. Bid Documents will be prepared simply and economically, providing straightforward and concise description of the Vendor's capabilities to satisfy the requirements of the Bid Documents. Emphasis should be on completeness and clarity of content. Elaborate brochures and other representations beyond that sufficient to present a complete and effective Bid Document are neither required nor desired.

### **B. PUBLIC INFORMATION ACT (PIA)**

1. Worcester County is subject to the Maryland Public Information Act and may be required to release bid submissions in accordance with the Act.
2. Any materials the Vendor deems to be proprietary or copyrighted must be marked as such; however, the material may still be subject to analysis under the Maryland Public Information Act.
  - a. The Vendor may invoke proprietary information or trade secret protection for submission of any data/material by (1) identifying the data/material in a written description, (2) clearly marking the data/material as proprietary, and (3) providing a written statement detailing the reasons why protection is necessary. The County reserves the right to ask for additional clarification prior to establishing protection.

### **C. CONTRACT AWARD**

1. A written award by the County to the Successful Vendor in the form of a Purchase Order or other contract document will result in a binding Contract without further action by either party. If the Successful Vendor fails or refuses to sign and deliver the Contract and the required insurance documentation, the County will have the right to award to the next responsible and responsive Vendor. Contract will be executed by the Successful Vendor within fourteen calendar days of receipt of the Contract.
2. Bid Documents and Contracts issued by the County will bind the Vendor to applicable conditions and requirements herein set forth, unless otherwise specified in the Bid Documents, and are subject to all federal, state, and municipal laws, rules, regulations, and limitations.
3. County personal property taxes ("Taxes") must be on a current basis; if any such Taxes are delinquent, they must be paid before award of Contract. Failure to pay will result in the award of Contract to another Vendor.
4. The County reserves the right to engage in individual discussions and interviews with those Vendors deemed fully qualified, responsible, suitable and professionally competent to provide the required Goods and/or Services should the project size warrant it. Vendors will be encouraged to elaborate on their qualifications, performance data, and staff expertise.

### **D. AUDIT**

1. The Successful Vendor agrees to retain all books, records, and other documents relative to the awarded Contract for five years after final payment, or until audited. The County, its authorized agents, and/or State auditors will have full access to and the right to examine any of said materials during said period.

### **E. NONPERFORMANCE**

1. The County reserves the right to inspect all operations and to withhold payment for any goods not performed or not performed in accordance with the specifications in this Bid Document. Errors, omissions or mistakes in performance will be corrected at no cost to the County. Failure to do so

will be cause for withholding of payment for that Goods and/or Services. In addition, if deficiencies are not corrected in a timely manner, the County may characterize the Successful Vendor as uncooperative, which may jeopardize future project order solicitations.

**F. MODIFICATION OR WITHDRAWAL OF BID**

1. A Bid Document may not be modified, withdrawn, or cancelled by the Vendor during the stipulated time period following the time and date designated for the receipt of Bid Documents, and each Vendor so agrees in submitting Bid Documents.

**G. DEFAULT**

1. The Contract may be cancelled or annulled by the County in whole or in part by written notice of default to the Successful Vendor upon non-performance, violation of Contract terms, delivery failure, bankruptcy or insolvency, any violation of state or local laws, or the making of an assignment for the benefit of creditors. An award may then be made to the next most highly rated Vendor, or when time is of the essence, similar commodities and/or service may be purchased on the open market. In either event, the defaulting Vendor (or his surety) will be liable to the County for cost to the County in excess of the defaulted Contract price.
2. If a representative or warranty of either Party to the Contract is false or misleading in any material respect, or if either Party breaches a material provision of the Contract (“Cause”), the non-breaching Party will give the other Party written notice of such cause. If such Cause is not remedied within fifteen calendar days (“Cure Period”) after receipt of such notice, (unless, with respect to those Causes which cannot be reasonably corrected or remedied within the Cure Period, the breaching Party will have commenced to correct or remedy the same within such Cure Period and thereafter will proceed with all due diligence to correct or remedy the same), the Party giving notice will have the right to terminate this Contract upon the expiration of the Cure Period.

**H. COLLUSION/FINANCIAL BENEFIT**

1. The Vendor certifies that his/her Bid is made without any previous understanding, agreement, or connection with any person, firm, or corporation making a Bid Document for the same project; without prior knowledge of competitive prices; and is in all respects fair, without outside control, collusion, fraud, or otherwise illegal action.
2. Upon signing the Bid Document, Vendor certifies that no member of the governing body of the County, or members of his/her immediate family, including spouse, parents or children, or any other officer or employee of the County, or any member or employee of a Commission, Board, or Corporation controlled or appointed by the County Commissioners has received or has been promised, directly or indirectly, any financial benefit, related to this Bid Document and subsequent Contract.

**I. TAX EXEMPTION**

1. In buying products directly from a Vendor, Worcester County is exempt from being *directly* charged Federal excise and Maryland sales tax. A copy of an exemption certificate shall be furnished upon request.
2. According to the Office of the Comptroller of Maryland, a *Contractor is responsible for paying sales tax* on his/her purchases relating to any projects or services and should incorporate it into their bid.
3. Successful Vendors **cannot** use the County tax exemption to buy materials or products used on County projects.



**J. CONTRACT CHANGES**

1. No claims may be made by anyone that the scope of the project or that the Vendor's Goods and/or Services have been changed (requiring changes to the amount of compensation to the Vendor or other adjustments to the Contract) unless such changes or adjustments have been made by an approved written amendment (Change Order) to the Contract signed by the Chief Administrative Officer (and the County Commissioners, if required), prior to additional Goods and/or Services being initiated. Extra Goods and/or Services performed without prior, approved, written authority will be considered as unauthorized and at the expense of the Vendor. Payment will not be made by the County.
2. No oral conversations, agreements, discussions, or suggestions, which involve changes to the scope of the Contract, made by anyone including any County employee, will be honored or valid. No written agreements or changes to the scope of the Contract made by anyone other than the Procurement Officer (with the Chief Administrative Officer and/or County Commissioners approval, if required) will be honored or valid.
3. If any Change Order in the Goods and/or Services results in a reduction in the Goods and/or Services, the Vendor will neither have, nor assert any claim for, nor be entitled to any additional compensation for damages or for loss of anticipated profits on Goods and/or Services that are eliminated.

**K. ADDENDUM**

1. No oral statements of any person will modify or otherwise affect or interpret the meaning of the Contract specifications, or the terms, conditions, or other portions of the Contract. All modifications and every request for any interpretation must be addressed to Worcester County's Procurement Officer and to be given consideration, must be received no later than the last day for questions listed in Section I, Subsection C.2.
2. Any and all interpretations, corrections, revisions, and amendments will be issued by the Procurement Officer to all holders of Bid Documents in the form of written addenda. Vendors are cautioned that any oral statements made by any County employee that materially change any portion of the Bid Documents cannot be relied upon unless subsequently ratified by a formal written amendment to the Bid Document.
3. All addenda will be issued so as to be received at least five days prior to the time set for receipt of Bid Documents, and will become part of the Contract and will be acknowledged in the Bid Document form. Failure of any Vendor to receive any such addenda will not relieve said Vendor from any obligation under the Bid Document as submitted.
4. Vendors are cautioned to refrain from including in their Bid Document any substitutions which are not confirmed by written addenda. To find out whether the County intends to issue an amendment reflecting an oral statement made by any employee, contact Worcester County's Procurement Officer during normal business hours.
5. The Worcester County Procurement Officer reserves the right to postpone the Bid Document opening for any major changes occurring in the five-day interim which would otherwise necessitate an Addendum.

**L. EXCEPTIONS/ SUBSTITUTIONS**

1. Any exceptions or substitutions to the specifications requested should be marked on the bid form and listed on a separate sheet of paper attached to the bid.

2. An exception to the specifications may disqualify the bid. The County will determine if the exception is an essential deviation or a minor item.
3. In the case of a minor deviation, the County maintains the option to award to that Vendor if it determines the performance is not adversely affected by the exception.

**M. APPROVED EQUALS**

1. In all specifications where a material or article is defined by describing a proprietary product or by using the name of a Vendor or manufacturer, it can be assumed that an approved equal can be substituted.
2. The use of a named product is an attempt to set a particular standard of quality and type that is familiar to the County. Such references are not intended to be restrictive.
3. However, the County shall decide if a product does in fact meet or exceed the quality of the specifications listed in the solicitation. It shall be the responsibility of the Vendor that claims his product is an equal to provide documentation to support such a claim.

**N. DELIVERY**

1. All items shall be delivered F.O.B. destination and delivery costs and charges included in the bid unless otherwise stated in the specifications or bid form.

**O. INSURANCE**

1. If required by the General Conditions or Terms and Conditions, the Successful Vendor shall provide the County with Certificates of Insurance within ten calendar days of bid award notification evidencing the required coverage.
2. Successful Vendor must provide Certificates of Insurance before commencing work in connection with the Contract.

**P. BID EVALUATION**

1. Bid tabulations will be posted on the County website at <https://www.co.worcester.md.us/commissioners/bids>. Click on the Expired Bids & Results tab and find the bid tabulation for the bid you are interested in. Bid tabulations will be posted as soon as reasonably possible after the Bid opening.

**END OF SECTION**

## **SECTION III: GENERAL CONDITIONS**

### **A. DRAWINGS AND SPECIFICATIONS**

1. Should any detail be omitted from the drawings or specifications, or should any errors appear in either, it shall be the duty of the Successful Vendor to notify the County's designated construction inspector.
2. In no case shall the Successful Vendor proceed with the work without notifying and receiving definite instructions from the County. Work wrongly constructed without such notification shall be corrected by the Successful Vendor at his own cost.

### **B. MATERIALS, SERVICES AND FACILITIES**

1. It is understood that, except as otherwise specifically stated in the Bid Documents, the Successful Vendor will provide and pay for all materials, labor, tools, equipment, water, light, power and transportation, supervision, temporary construction of any nature, and all other services and facilities of any nature whatsoever necessary to execute, complete, and deliver the Work within the specified time.
2. Materials and equipment will be so stored as to insure the preservation of their quality and fitness for the Work. Stored materials and equipment to be incorporated in the Work will be located so as to facilitate prompt inspection.
3. Manufactured articles, materials, and equipment will be applied, installed, connected, erected, used, cleaned and conditioned as directed by the manufacturer.
4. Materials, supplies and equipment will be in accordance with samples submitted by the Successful Vendor and approved by the County.

### **C. INSPECTION AND TESTING**

1. All materials and equipment used in the construction of the Work will be subject to adequate inspection and testing in accordance with generally accepted standards, as required and defined in the Bid Documents.
2. The County or its representatives may, at any time, enter upon the work and the premises used by the Successful Vendor, and the Successful Vendor shall provide proper and safe facilities to secure convenient access to all parts of the work, and all other facilities necessary for inspection, as may be required.
3. The County will appoint such persons as deemed necessary to properly inspect the materials furnished or to be furnished, and the work done under the contract and to see that the same strictly corresponds with the drawings and specifications. All such materials and workmanship shall be subject to approval of the County. Approval or acceptance of payment shall not be misconstrued as approval of items or work not in conformance with specifications and drawings nor shall it prevent the rejection of said work or materials at any time thereafter during the existence of the contract, should said work or materials be found to be defective, or not in accordance with the requirements of the contract.
4. Work and material will be inspected promptly, but if for any reason should a delay occur, the Successful Vendor shall have no claim for damages or extra compensation.
5. The Successful Vendor shall pay for all inspection costs necessary to complete the work which may be incurred to comply with the requirements of any agency other than the County, such as a railroad, public service utility company, or any other governmental agency or any other agency whose jurisdiction affects the work in any manner unless otherwise specified herein.

**D. APPROVAL OF SUBSTITUTION OF MATERIALS**

1. Samples of materials shall be submitted by the Successful Vendor for approval before such materials are ordered from the manufacturers or distributors and shall be approved by the County before actual work is begun.
2. It is the intention of these specifications to permit all vendors bidding on this work to secure the fullest amount of competition on the various materials and specialties names herein. Wherever a material or article is defined by describing a proprietary product or by using the name of a vendor or manufacturer, the term or approved equal shall be presumed to be implied unless otherwise stated.

**E. PROTECTION OF WORK, PROPERTY AND PERSONS**

1. Successful Vendor will be responsible for initiating, maintaining and supervising all safety precautions and programs in connection with the Work. Successful Vendor will take all necessary precautions and programs in connection with the Work. Successful Vendor will take all necessary precautions for the safety of, and will provide the necessary protection to prevent damage, injury or loss to, all employees on the Work and other persons who may be affected thereby, all the Work and all materials or equipment to be incorporated therein, whether in storage on off the site, and other property at the site or adjacent thereto, including trees, shrubs, lawns, walks, pavements, roadways, structures and utilities not designated for removal, relocation or replacement in the course of construction.
2. Successful Vendor will comply with all applicable laws, ordinances, rules, regulations and orders of any public body having jurisdiction. Successful Vendor will erect and maintain, as required by the conditions and progress of the Work, all necessary safeguards for safety and protection. Successful Vendor will notify owners of adjacent utilities when progress of the Work may affect them. The Successful Vendor will remedy all damage, injury or loss to any property caused, directly or indirectly, in whole or in part, by Successful Vendor, any Subcontractor or anyone directly or indirectly employed by any of them or anyone for whose acts any of them be liable.
3. In emergencies affecting the safety of persons or the Work or property at the site or adjacent thereto, the Successful Vendor, without special instruction or authorization from the County, will act to prevent threatened damage, injury or loss. Successful Vendor will give the County prompt Written Notice of any significant changes in the Work or deviations from the Bid Documents caused thereby, and a Change Order will thereupon be issued covering the changes and deviations involved.

**F. BARRICADES, DANGER, WARNING AND DETOUR SIGNS**

1. The Successful Vendor shall provide, erect and maintain all necessary barricades, sufficient red lights, flares, danger signals and signs, provide a sufficient number of watchmen and take all necessary precautions for the protection of the work and safety of the public.

**G. LICENSES AND PERMITS**

1. The Successful Vendor shall have all necessary licenses required to do the work and give all notices and obtain and pay all necessary permits required by local laws and regulations for building.
2. State and Federal permits (if applicable) to undertake work have been obtained by the County and accompany these specifications.

**H. SUPERVISION**

1. The Successful Vendor shall maintain, at all times during the progress of work, a competent and experienced supervisor who shall represent the Successful Vendor, and all directions given to him shall be binding. Important decisions regarding directions, if requested by the supervisor, shall be confirmed in writing.
2. Supervision by the County or its representative does not relieve the Successful Vendor of responsibility for defective work executed under the direct control of the Successful Vendor. Responsibility for defective work rests upon the Successful Vendor, whether discovered by the County prior to final payment or subsequent thereto.

**I. CLEAN UP**

1. Upon completion of the items within a given location as specified and before monthly estimates will be paid, the construction area and all other areas occupied by the Successful Vendor during the construction of said Contract shall be cleaned of all surplus and discarded materials, bracing, forms, rubbish and temporary structures that were placed there by the Successful Vendor.
2. Disposal of the aforementioned shall be the responsibility of the Successful Vendor.

**J. CHANGES IN WORK**

1. The County, without invalidating the contract, may order extra work or make changes by altering, adding or deducting from the work with the contract sum being adjusted accordingly.
2. All such work shall be executed under the conditions of the original contract, except that any claim for the extension of time caused thereby shall be adjusted at the time of ordering such change.
3. The value of any such extra work or change shall be determined in one or more of the following ways:
  - a. By estimate and acceptance of lump sum.
  - b. By unit prices named in the contract or subsequently agreed upon.

**K. TIME FOR COMPLETION**

1. The Work contemplated under this Contract shall be considered as continuous and be completed within the timeframe(s) stated in Section IV of this Bid Document.
2. The Successful Vendor will be allowed to work eight hours per day, Monday through Friday, except for holidays, fifty-two weeks per year.
3. The Successful Vendor will not be permitted to work on holidays observed by Worcester County or the State of Maryland or on Sundays unless otherwise authorized in writing.
4. In case of an emergency which may require that work be done on Saturdays, Sundays, and Holidays, the Successful Vendor shall request permission of the County to do so. If, in the opinion of the County, the emergency is bonafide, permission may be granted to the Successful Vendor to work such hours as may be determined are necessary by the County. Also, if in the opinion of the County a bonafide emergency exists, the Successful Vendor may be directed to work such hours as may be necessary whether or not the Successful Vendor requests permission to do so.
5. The Successful Vendor shall pay the County for all costs incurred for inspection services required for work permitted during holidays, weekends or in excess of eight hours per day.

**L. LIQUIDATED DAMAGES**

- 1. If the Successful Vendor shall fail to start and complete the project within the time frame stated above, the County shall assess liquidated damages in the amounts listed below per calendar day for each and every day the Successful Vendor fails to complete the contract.

<u>Amount of Contract</u>	<u>Liquidated Damages per Day</u>
Less than \$10,000	\$100.00
\$10,000 or less than \$100,000	\$250.00
\$100,000 or less than \$500,000	\$750.00
\$500,000 or more	\$1,000.00
Or will be based on actual cost to the County, whichever is greater.	

- 2. The designated County project manager reserves the option to extend the scheduled completion date or waive the liquidated damages clause in its entirety if he is of the opinion that extenuating circumstances deemed such action appropriate.

**M. CORRECTION OF WORK**

- 1. The Successful Vendor will promptly remove from the premises all Work rejected by the County for failure to comply with the Bid Documents, whether incorporated in the construction or not, and the Successful Vendor will promptly replace and re-execute the Work in accordance with the Bid Documents and without expense to the County and will bear the expense of making good all Work of other Vendors destroyed or damaged by such removal or replacement.
- 2. All removal and replacement Work will be done at the Successful Vendor’s expense. If the Successful Vendor does not act to remove such rejected Work within ten days after receipt of Written Notice, the County may remove such Work and store the materials at the expense of the Successful Vendor.

**N. CONSTRUCTION SAFETY AND HEALTH STANDARDS**

- 1. It is a condition of this contract, and shall be made a condition of each sub-contract entered into pursuant to this contract, that the Successful Vendor and any sub-contractor shall not require any laborer or mechanic employed in performance of the contract to work in surroundings or under working conditions which are unsanitary, hazardous, or dangerous to his health or safety, as determined under construction safety and health standards (Title 29, Code of Federal Regulations, Part 1926, formerly Part 1518, as revised from time to time, promulgated by the United States Secretary of Labor, in accordance with Section 107 of the Contract Work Hours and Safety Standard Act.) (83 Stat. 96).
- 2. Failure of Worcester County to inform the Successful Vendor of safety violations will not release the Successful Vendor of his responsibilities.

**O. BID BOND**

- 1. Bid Documents must be accompanied by a Bid Bond if the Vendor’s total Bid amount exceeds \$100,000, payable to the County for five percent of the total amount of the bid. After the analysis of the Bid Documents the County will return Bid Bonds to all Vendors except the three lowest Responsive and Responsible Vendors. After execution of the Contract, and receipt, execution, and approval of the Successful Vendor’s Payment and Performance bond, the Bid Bonds will be returned. A certified check may be used in lieu of a Bid Bond.

2. The County, at its discretion, may consider a Vendor in default if the Vendor fails to execute the Contract, in which the County will retain said Bid Bond.

**P. PERFORMANCE AND PAYMENT BONDS**

1. The Successful Vendor will be required to provide the County with a Performance Bond and Payment Bond if the total Contract amount exceeds \$100,000, each in the amount of one hundred percent of the Contract Price, with a corporate surety approved by the County for the faithful performance of the Contract.
2. The Successful Vendor will within fourteen calendar days after the receipt of the Contract furnish the County with a Performance Bond and Payment Bond in penal sums equal to the amount of the Contract Price, conditioned upon the performance by the Successful Vendor of all undertakings, covenants, terms, conditions and agreements of the Bid Documents, and upon the prompt payment by the Successful Vendor to all persons supplying labor and materials in the prosecution of the Work provided by the Bid Document. Such Bonds will be executed by the Successful Vendor and corporate bonding company licensed to transact such business in the state in which the Work is to be performed and named on the current list of "Surety Companies Acceptable on Federal Bonds" as published in the Circular Number 570. The expense of these Bonds will be borne by the Successful Vendor. If at any time a surety on any such Bond is declared bankrupt or loses its right to do business in the State of Maryland or is removed from the list of surety companies accepted on federal bonds, Successful Vendor will within ten calendar days after notice from the County to do so, substitute an acceptable Bond(s) in such form and sum and signed by such other surety or sureties as may be satisfactory to the County.

**Q. GUARANTEE**

1. The Successful Vendor shall furnish the County with a one-year guarantee of workmanship and materials, dating from time of acceptance of the project and shall make good any defects which may occur during that period.
2. If any special guarantees in excess of the one-year period are specified by the manufacturer, these guarantees shall take precedence over the one-year period guarantee.
3. Upon completion of work, and before final payment or release of retainage, the Successful Vendor shall submit, and obtain from each subcontractor, material supplier and equipment manufacture general warranties and a notarized asbestos free guarantee.

**END OF SECTION**

## **SECTION IV: BID SPECIFICATIONS**

### **A. SCOPE**

1. The County is seeking bids from qualified Vendors for the replacement of approximately 295 linear feet of existing timber bulkhead with a new vinyl sheet bulkhead system, including new tieback system in accordance with the terms and conditions and specifications set forth in this solicitation.
2. Work includes bulkhead replacement, but not replacement of the boat ramp.
3. This bid package is for phase II of a two-phase project. The attached drawings include both phases.

### **B. CONTRACT PRICING**

1. Pricing must include all labor, materials, tools, and equipment to perform Work.
2. Pricing will not change during the Contract Period.

### **C. SUMMARY**

1. All materials shall be as specified.
2. As applicable, all materials shall be new and shall be delivered to the job site with labels intact and legible. The Successful Vendor shall be responsible for the proper storage of said materials throughout the project and shall replace, at no additional cost to the County any supplies or materials judged unacceptable by the County.
3. The Successful Vendor shall be responsible for the coordination, off-loading, and proper storage of all materials and supplies up until the time of final inspection and project acceptance.
4. Materials shall be stored in a safe area out of the way of traffic. The Parks Superintendent shall approve any on site storage location prior to the arrival of any materials. All materials shall be stored off the ground surface and should be protected from the weather with a waterproof covering. Any special storage instruction required by the material manufacturer shall be performed by the Successful Vendor as specified.
5. All work must be completed by March 1, 2024.

### **D. METHOD OF WORK**

1. All work shall be as called for in these written specifications.
2. The Successful Vendor shall adhere to OSHA MOSHA regulations throughout the project to insure the safety of his/her employees, state employees, and the public.
3. The Successful Vendor shall maintain the work site in a safe, neat, and orderly manner throughout the entire project. The Successful Vendor shall take steps necessary to prevent the accumulation of debris at the job site.

### **E. GENERAL REQUIREMENTS**

1. The Successful Vendor must be licensed to perform Work in the state of Maryland.

### **F. PRE-BID CONFERENCE**

1. A pre-bid meeting has been scheduled for **Monday, August 28, 2023 at 1:15pm** on-site at 5820 South Point Rd Berlin, MD 21811.

### **G. ATTACHMENTS**

1. South Point Bulkhead Drawings – Dated February 2022
2. Approved Maryland Department of Environment General Tidal Wetlands Permit

### **H. PAYMENT**

1. The County will make payment(s) to the Successful Vendor within thirty (30) calendar days from the receipt of a proper invoice for approved and accepted work performed.



**I. QUESTIONS**

1. The last day for questions is listed under Section I, Subsection C.2.

**J. AWARD**

1. The County intends to award to the lowest Responsive and Responsible Vendor meeting the specifications.

**END OF SECTION**

**THIS AND PREVIOUS SECTIONS, OTHER THAN THE COVER PAGE, DO NOT NEED TO BE  
RETURNED WITH SUBMITTAL**

## FORM OF BID

To whom it may concern:

We hereby submit our Bid Documents for “SOUTH POINT BULKHEAD REPLACEMENT PHASE II” as indicated in the Bid Documents. Having carefully examined the Bid Documents and having received clarification on all items of conflict or upon which any doubt arose, the undersigned hereby requests consideration of our Vendor for award of the referenced Bid.

ITEM	DESCRIPTION	EXTENDED PRICE
1	Provide labor, materials and equipment for the replacement of approximately 295 linear feet of existing timber bulkhead with a new vinyl sheet bulkhead system, including new tieback system as stated in the Bid Specifications.	

Vendor agrees to have the Work completed no later than March 1, 2024. (Yes)\_\_\_\_ (No) \_\_\_\_\_ Check One.

Have you included your certificate of good standing with the State of Maryland? (See Section I, Subsection H.1 for more information.) (Yes)\_\_\_\_ (No) \_\_\_\_\_ Check One.

Is your company currently involved in any active litigation? (Yes)\_\_\_\_ (No) \_\_\_\_\_ Check One.

Is your company currently involved in any mergers or acquisitions? (Yes)\_\_\_\_ (No) \_\_\_\_\_ Check One.

The Vendor agrees that their bid will be good for at least sixty days unless otherwise indicated in the bid specifications.

Note: This bid form must be signed by an officer of your company or an authorized agent for this bid to be considered valid by the county.

\_\_\_\_\_  
Sign for Identification

\_\_\_\_\_  
Printed Name

\_\_\_\_\_  
Title

\_\_\_\_\_  
Email

## REFERENCES

List three references for which the Vendor has provided Goods/Services similar to those requested in the Bid Document within the last 12-36 months. Include contact name, address, telephone number, email address and services provided.

Company Name:		Company Name:	
Type of Project:		Type of Project:	
Address:		Address:	
Town, State, Zip Code:		Town, State, Zip Code:	
Contact Person:		Contact Person:	
Telephone Number:		Telephone Number:	
Email:		Email:	
Date of Service:		Date of Service:	
Company Name:			
Type of Project:			
Address:			
Town, State, Zip Code:			
Contact Person:			
Telephone Number:			
Email:			
Date of Service:			

\_\_\_\_\_  
Sign for Identification

\_\_\_\_\_  
Printed Name

## EXCEPTIONS

The undersigned hereby certifies that, except as listed below, or on separate sheets attached hereto, the enclosed Completed Bid Document covers all items as specified.

**EXCEPTIONS:**

(If none, write none) \_\_\_\_\_

How did you hear about this solicitation?

- Worcester County's Website
- eMaryland Marketplace Advantage (eMMA)
- Newspaper Advertisement
- Direct email
- Other \_\_\_\_\_

The vendor hereby acknowledges receipt of the following addenda.

<u>Number</u>	<u>Date</u>	<u>Initials</u>
_____	_____	_____
_____	_____	_____
_____	_____	_____

\_\_\_\_\_  
Sign for Identification

\_\_\_\_\_  
Printed Name

**INDIVIDUAL PRINCIPAL**

Vendor Name: \_\_\_\_\_

Signed By: \_\_\_\_\_ In the presence of: \_\_\_\_\_

Address of Vendor: \_\_\_\_\_ Town, State, Zip \_\_\_\_\_

Telephone No.: \_\_\_\_\_ Fax: \_\_\_\_\_ Email: \_\_\_\_\_

\*\*\*\*\*

**CO-PARTNERSHIP PRINCIPAL**

Name of Co-Partnership: \_\_\_\_\_

Address: \_\_\_\_\_ Town, State, Zip

\_\_\_\_\_

Telephone No.: \_\_\_\_\_ Fax: \_\_\_\_\_

Signed By: \_\_\_\_\_ In the presence of: \_\_\_\_\_

Partner

Witness

Signed By: \_\_\_\_\_ In the presence of: \_\_\_\_\_

Partner

Witness

Signed By: \_\_\_\_\_ In the presence of: \_\_\_\_\_

Partner

Witness

\*\*\*\*\*

**CORPORATE PRINCIPAL**

Name of Corporation: \_\_\_\_\_

Address: \_\_\_\_\_ Town, State, Zip

\_\_\_\_\_

Telephone No.: \_\_\_\_\_ Fax:

\_\_\_\_\_

Signed By: \_\_\_\_\_ In the presence of: \_\_\_\_\_

President

Witness

Attest: \_\_\_\_\_

Corporate Secretary

Affix Corporate Seal

## VENDOR'S AFFIDAVIT OF QUALIFICATION TO BID

I HEREBY AFFIRM THAT:

I, \_\_\_\_\_ am the \_\_\_\_\_  
(Printed Name) (title)  
and the duly authorized representative of the Vendor of  
\_\_\_\_\_ whose address is  
(name of corporation)

\_\_\_\_\_

and that I possess the legal authority to make this affidavit on behalf of myself and the Vendor for which I am acting.

Except as described in paragraph 3 below, neither I nor the above Vendor, nor to the best of my knowledge and of its officers, directors or partners, or any of its employees directly involved in obtaining contracts with the State or any county, bi-county or multi-county agency, or subdivision of the State have been convicted of, or have pleaded nolo-contendere to a charge of, or have during the course of an official investigation or other proceeding admitted in writing or under oath acts or omissions which constitute, bribery, attempted bribery, or conspiracy to bribe under the provisions of Article 27 of the Annotated Code of Maryland or under the laws of any state or federal government (conduct prior to July 1, 1977 is not required to be reported).

(State "none" or, as appropriate, list any conviction, plea or admission described in paragraph 2 above, with the date, court, official or administrative body, the individuals involved and their position with the Vendor, and the sentence or disposition, if any.)

\_\_\_\_\_

\_\_\_\_\_

I acknowledge that this affidavit is to be furnished to the County, I acknowledge that, if the representations set forth in this affidavit are not true and correct, the County may terminate any Contract awarded and take any other appropriate action. I further acknowledge that I am executing this affidavit in compliance with section 16D of Article 78A of the Annotated Code of Maryland, which provides that certain persons who have been convicted of or have admitted to bribery, attempted bribery or conspiracy to bribe may be disqualified, either by operation of law or after a hearing, from entering into contracts with the State or any of its agencies or subdivisions.

I do solemnly declare and affirm under the penalties of perjury that the contents of this affidavit are true and correct.

\_\_\_\_\_  
Sign for Identification

\_\_\_\_\_  
Printed Name

## NON-COLLUSIVE AFFIDAVIT

\_\_\_\_\_ being first duly sworn,  
deposes and says that:

1. He/she is the \_\_\_\_\_, (Owner, Partner, Officer, Representative or Agent) of \_\_\_\_\_, the Vendor that has submitted the attached Bid Documents;
2. He/she is fully informed respecting the preparation and contents of the attached Bid Document and of all pertinent circumstances respecting such Bid Documents;
3. Such Bid Document is genuine and is not a collusive or sham Bid Document;
4. Neither the said Vendor nor any of its officers, partners, owners, agents, representatives, employees or parties in interest, including this affiant, have in any way colluded, conspired, connived or agreed, directly or indirectly, with any other Vendor, firm, or person to submit a collusive or sham Bid Document in connection with the Work for which the attached Bid Document has been submitted; or to refrain from bidding in connection with such Work; or have in any manner, directly or indirectly, sought by agreement or collusion, or communication, or conference with any Vendor, firm, or person to fix the price or prices in the attached Bid Document or of any other Vendor, or to fix any overhead, profit, or cost elements on the Bid Document price or the Bid Document price of any other Vendor, or to secure through any collusion, conspiracy, connivance, or unlawful agreement any disadvantage against (Recipient), or any person interested in the Work;
5. The price or prices quoted in the attached Bid Document are fair and proper and are not tainted by any collusion, conspiracy, connivance, or unlawful agreement on the part of the Vendor or any other of its agents, representatives, owners, employees or parties in interest, including this affiant.

Signed, sealed and delivered in the presence of:

\_\_\_\_\_  
Witness

\_\_\_\_\_  
Witness

By: \_\_\_\_\_  
Signature

\_\_\_\_\_  
Printed Name

\_\_\_\_\_  
Title

## EXHIBIT A

### WORCESTER COUNTY MARYLAND STANDARD TERMS AND CONDITIONS

The provisions below are applicable to all Worcester County (“County”) contracts. These provisions are not a complete agreement. These provisions must be attached to an executed document that identifies the work to be performed, compensation, term, incorporated attachments, and any special conditions (“Contract”). If the Standard Terms and any other part of the Contract conflict, then the Standard Terms will prevail.

1. **Amendment.** Amendments to the Contract must be in writing and signed by the parties.
2. **Bankruptcy.** If a bankruptcy proceeding by or against the Contractor is filed, then:
  - a. The Contractor must notify the County immediately; and
  - b. The County may cancel the Contract or affirm the Contract and hold the Contractor responsible for damages.
3. **Compliance with Law.** Contractor must comply with all applicable federal, state, and local law. Contractor is qualified to do business in the State of Maryland. Contractor must obtain, at its expense, all licenses, permits, insurance, and governmental approvals needed to perform its obligations under the Contract.
4. **Contingent Fee Prohibition.** The Contractor has not directed anyone, other than its employee or agent, to solicit the Contract and it has not promised to pay anyone a commission, percentage, brokerage fee, contingent fee, or other consideration contingent on the making of the Contract.
5. **Counterparts and Signature.** The Contract may be executed in several counterparts, each of which may be an original and all of which will be the same instrument. The Contract may be signed in writing or by electronic signature, including by email. An electronic signature, a facsimile copy, or computer image of the Contract will have the same effect as an original signed copy.
6. **Exclusive Jurisdiction.** All legal proceedings related to this Contract must be exclusively filed, tried, and maintained in either the District Court of Maryland for Worcester County, Maryland or the Circuit Court of Worcester County, Maryland. The parties expressly waive any right to remove the matter to any other state or federal venue and waive any right to a jury trial.
7. **Force Majeure.** The parties are not responsible for delay or default caused by fire, riot, acts of God, County-declaration-of-emergency, or war beyond their reasonable control. The parties must make all reasonable efforts to eliminate a cause of delay or default and must, upon cessation, diligently pursue their obligations under the Contract.
8. **Governing Law.** The Contract is governed by the laws of Maryland and the County.
9. **Indemnification.** The Contractor must indemnify the County and its agents from all liability, penalties, costs, damages, or claims (including attorney’s fees) resulting from personal injury, death, or damage to property that arises from or is connected to the performance of the work or failure to perform its obligations under the Contract. All indemnification provisions will survive the expiration or termination of the Contract.



**10. Independent Contractor.**

- a. Contractor is an “Independent Contractor”, not an employee. Although the County may determine the delivery schedule for the work and evaluate the quality of the work, the County will not control the means or manner of the Contractor’s performance.
- b. Contractor is responsible for all applicable taxes on any compensation paid under the Contract. Contractor is not eligible for any federal Social Security, unemployment insurance, or workers’ compensation benefits under the Contract.
- c. Contractor must immediately provide the County notice of any claim made against Contractor by any third party.

**11. Insurance Requirements.**

- a. Contractor must have Commercial General Liability Insurance in the amounts listed below. The insurance must include coverage for personal injury, discrimination, and civil rights violation claims. All insurance must name County, its employees, and agents as “ADDITIONAL INSURED”. A copy of the certificate of insurance must be filed with the County before the Contract is executed, providing coverage in the amount of \$1,000,000 per occurrence, \$2,000,000 general aggregate, and \$500,000 for property damage.
- b. Contractor must have automobile insurance on all vehicles used in the Contract to protect Contractor against claims for damages resulting from bodily injury, including wrongful death, and property damage that may arise from the operations in connection with the Contract. All insurance must name County, its employees, and agents as “ADDITIONAL INSURED”.
- c. Contractor must provide the County with a certification of Workers’ Compensation Insurance, with employer’s liability in the minimum amount required by Maryland law in effect for each year of the Contract.
- d. All insurance policies must have a minimum 30 days’ notice of cancellation. The County must be notified immediately upon cancellation.
- e. When insurance coverage is renewed, Contractor must provide new certificates of insurance prior to expiration of current policies.

**12. Nondiscrimination.** Contractor must not discriminate against any worker, employee, or applicant because of religion, race, sex, age, sexual orientation, physical or mental disability, or perceived disability. This provision must be incorporated in all subcontracts related to the Contract.

**13. Ownership of Documents; Intellectual Property.**

- a. All documents prepared under the Contract must be available to the County upon request and will become the exclusive property of the County upon termination or completion of the services. The County may use the documents without restriction or without additional compensation to the Contractor. The County will be the owner of the documents for the purposes of copyright, patent, or trademark registration.
- b. If the Contractor obtains, uses, or subcontracts for any intellectual property, then it must provide an assignment to the County of ownership or use of the property.
- c. The Contractor must indemnify the County from all claims of infringement related to

the use of any patented design, device, materials, or process, or any trademark or copyright, and must indemnify the County, its officers, agents, and employees with respect to any claim, action, costs, or infringement, for royalties or user fees, arising out of purchase or use of materials, construction, supplies, equipment, or services covered by the Contract.

14. **Payments.** Payments to the Contractor under the Contract will be within 30 days of the County's receipt of a proper invoice from the Contractor. If an invoice remains unpaid 45 days after the invoice was received, interest will accrue at 6% per year.
15. **Records.** Contractor must maintain fiscal records relating to the Contract in accordance with generally accepted accounting principles. All other relevant records must be retained by Contractor and kept accessible for at least three years after final payment, termination of the Contract, or until the conclusion of any audit, controversy, or litigation related to the Contract. All subcontracts must comply with these provisions. County may access all records of the Contractor related to the Contract.
16. **Remedies.**
  - a. **Corrections of errors and omissions.** Contractor must perform work necessary to correct errors and omissions in the services required under the Contract, without undue delays and cost to the County. The County's acceptance will not relieve the Contractor of the responsibility of subsequent corrections of errors.
  - b. **Set-off.** The County may deduct from any amounts payable to the Contractor any back-charges, penalties, or damages sustained by the County, its agents, or employees caused by Contractor's breach. Contractor will not be relieved of liability for any costs caused by a failure to satisfactorily perform the services.
  - c. **Cumulative.** These remedies are cumulative and without waiver of any others.
17. **Responsibility of Contractor.**
  - a. The Contractor must perform the services with the standard of care, skill, and diligence normally provided by a Contractor in the performance of services similar the services.
  - b. Notwithstanding any review, approval, acceptance, or payment for the services by the County, the Contractor will be responsible for the accuracy of any work, design, drawings, specifications, and materials furnished by the Contractor under the Contract.
  - c. If the Contractor fails to conform with subparagraph (a) above, then it must, if required by the County, perform at its own expense any service necessary for the correction of any deficiencies or damages resulting from the Contractor's failure. This obligation is in addition to any other remedy available to the County.
18. **Severability/Waiver.** If a court finds any term of the Contract to be invalid, the validity of the remaining terms will not be affected. The failure of either party to enforce any term of the Contract is not a waiver by that party.
19. **Subcontracting or Assignment.** The Contractor may not subcontract or assign any part of the Contract without the prior written consent of the County. The County may withhold consent for any reason the County deems appropriate.

20. **Termination.** If the Contractor violates any provision of the Contract, the County may terminate the Contract by written notice. All finished or unfinished work provided by the Contractor will, at the County's option, become the County's property. The County will pay the Contractor fair compensation for satisfactory performance that occurred before termination less the amount of damages caused by the Contractor's breach. If the damages are more than the compensation payable to the Contractor, the Contractor will remain liable after termination and the County can affirmatively collect damages.
21. **Termination of Contract for Convenience.** Upon written notice, the County may terminate the Contract when the County determines termination is in the County's best interest. Termination for convenience is effective on the date specified in the County's written notice. The County will pay for reasonable costs allocable to the Contract for costs incurred by the Contractor up to the date of termination. But the Contractor will not be reimbursed for any anticipatory profits that have not been earned before termination.
22. **Termination of Multi-year Contract.** If funds are not available for any fiscal period of the Contract after the first fiscal period, then the Contract will be terminated automatically as of the beginning of unfunded fiscal period. Termination will discharge the Contractor and the County from future performance of the Contract, but not from their rights and obligations existing at the time of termination.
23. **Third Party Beneficiaries.** The County and Contractor are the only parties to the Contract and are the only parties entitled to enforce its terms. Nothing in the Contract gives any benefit or right to third persons unless individually identified by name and expressly described as intended beneficiaries of the Contract.
24. **Use of County Facilities.** Contractor may only County facilities that are needed to perform the Contract. County has no responsibility for the loss or damage to Contractor's personal property which may be stored on County property.
25. **Whole Contract.** The Contract, the Standard Terms, and attachments are the complete agreement between the parties and supersede all earlier agreements, proposals, or other communications between the parties relating to the subject matter of the Contract.

C:\Projects\2022\220133 South Point Bulk Ramp Bulkhead Design\Drawings\Current\South Point Bulkhead (220133).dwg, 7/1/2023 3:51 PM, User: FX, Title: 1.dwg

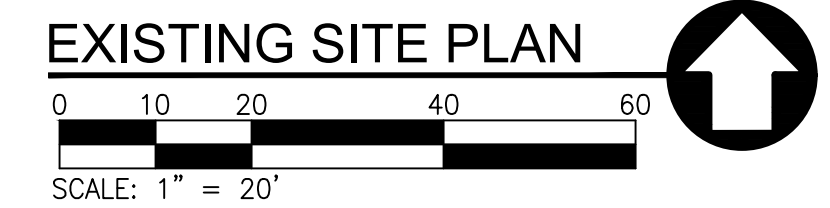
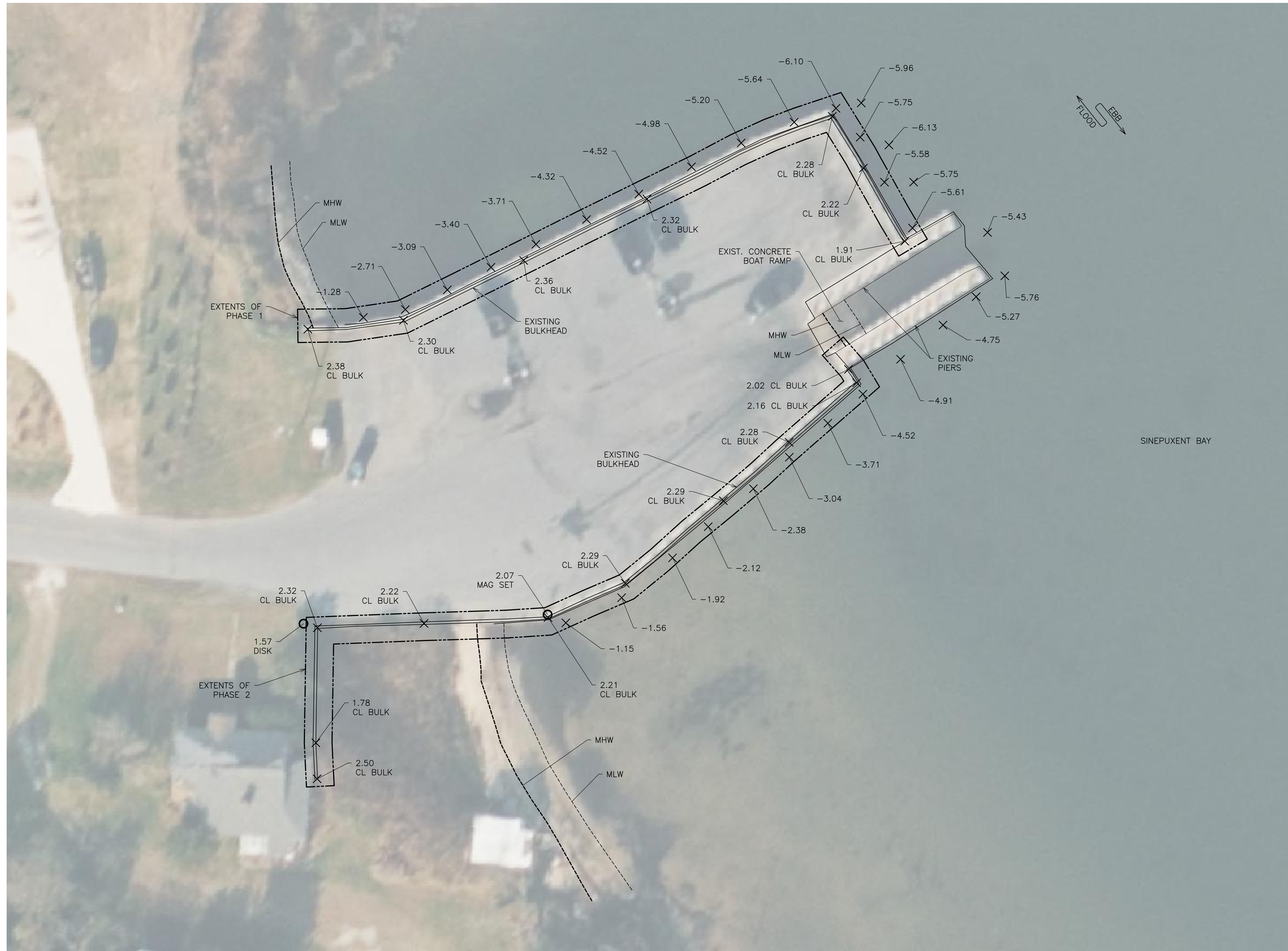

- NOTES:**
1. ALL ELEVATIONS ARE BASED ON NAVD88 DATUM AND STATE PLANE COORDINATES
  2. PRIOR TO START OF WORK, THE CONTRACTOR SHALL HAVE A LICENSED SURVEYOR FIELD MARK THE PROPERTY LINE FOR THE PROJECT SITE PARTICULARLY RELATED TO INTERFACES WITH ADJACENT PROPERTY OWNERS.
  3. CONTRACTOR SHALL ADHERE TO THE CONDITIONS OF THE APPROVED PERMITS FOR THE PROJECT.

PRINTS ISSUED FOR:  
REVIEW

REVISIONS		
REV #	DESCRIPTION	DATE
1		
2		
3		
4		
5		
6		
7		

**GMB**  
 GEORGE, MILES & BUHR, LLC  
 ARCHITECTS & ENGINEERS  
 SALISBURY • BALTIMORE • SEAFORD  
 206 DOWNTOWN PLAZA  
 SALISBURY, MARYLAND 21801  
 410-742-3115, FAX 410-548-5790  
 www.gmbnet.com

**SOUTHPOINT  
 BULKHEAD REPLACEMENT  
 WORCESTER COUNTY, MARYLAND**

**EXISTING  
 SITE PLAN**

SCALE: AS NOTED	SHEET NO.
DESIGN BY: ARM	<b>S1.1</b>
DRAWN BY: TFVT	
CHECKED BY: ARM	
GMB FILE: 220133	
DATE: FEB 2022	

© COPYRIGHT 2021 GEORGE, MILES & BUHR, LLC

C:\Projects\2022\220133 South Point Bulk Ramp Bulkhead Design\Drawings\Current\South Point Bulkhead (220133)Map\_7/1/2022 3:51 PM\_Tier FX.txd

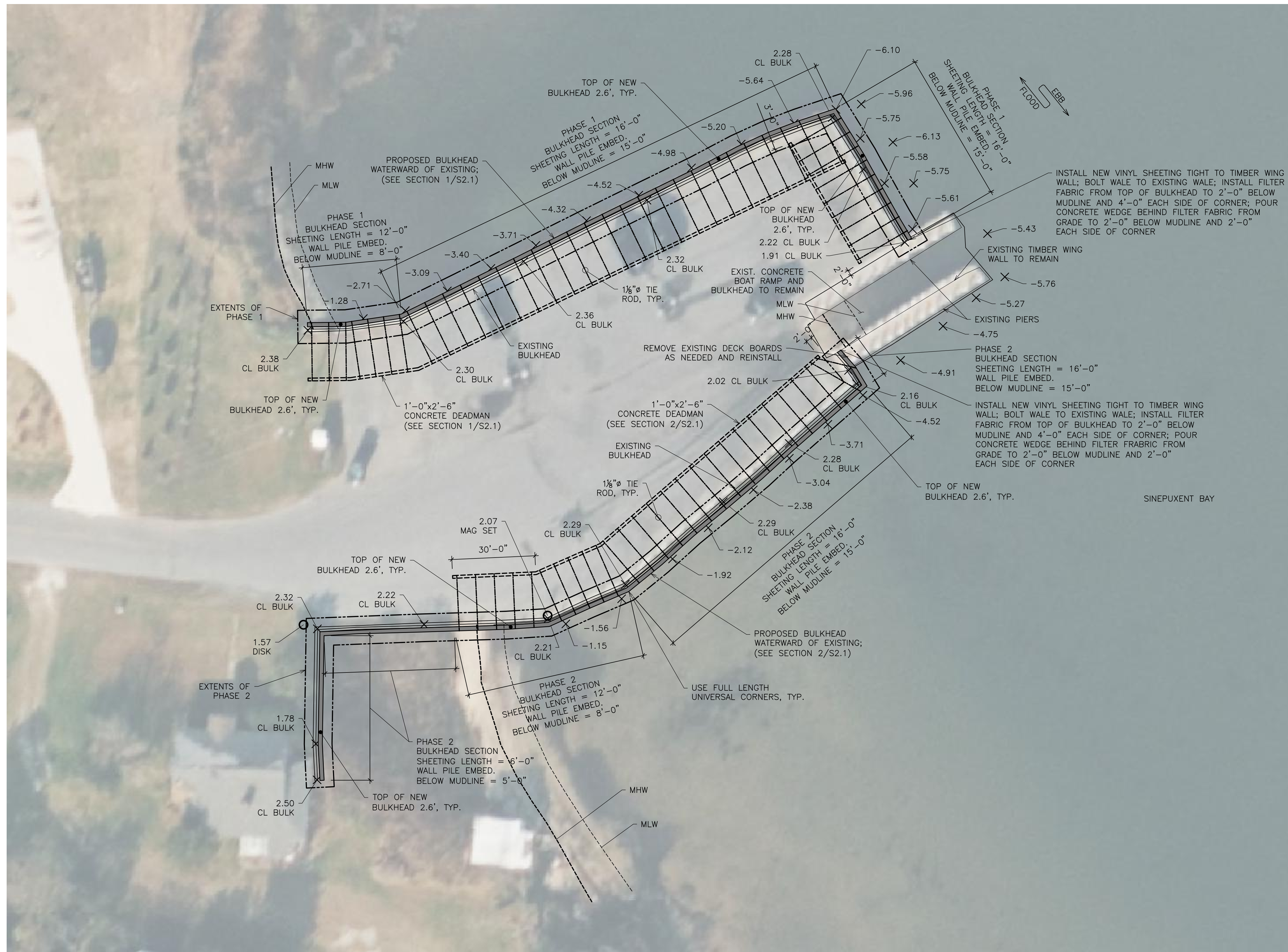

**PROPOSED SITE PLAN**

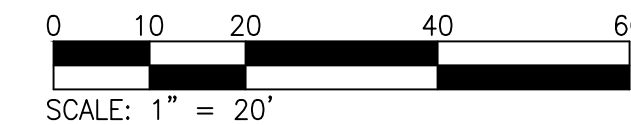

- NOTE:**
1. PRIOR TO START OF WORK, THE CONTRACTOR SHALL HAVE A LICENSED SURVEYOR FIELD MARK THE PROPERTY LINE FOR THE PROJECT SITE PARTICULARLY RELATED TO INTERFACES WITH ADJACENT PROPERTY OWNERS.
  2. CONTRACTOR SHALL ADHERE TO THE CONDITIONS OF THE APPROVED PERMITS FOR THE PROJECT.

PRINTS ISSUED FOR:  
REVIEW

REVISIONS		
REV #	DESCRIPTION	DATE
1		
2		
3		
4		
5		
6		
7		

**GMB**  
 GEORGE, MILES & BUHR, LLC  
 ARCHITECTS & ENGINEERS  
 SALISBURY • BALTIMORE • SEAFORD  
 206 DOWNTOWN PLAZA  
 SALISBURY, MARYLAND 21801  
 410-742-3115; FAX 410-548-5790  
 www.gmbnet.com

**SOUTHPOINT  
 BULKHEAD REPLACEMENT  
 WORCESTER COUNTY, MARYLAND**

**PROPOSED  
 SITE PLAN**

SCALE: AS NOTED	SHEET NO.
DESIGN BY: ARM	<b>S1.2</b>
DRAWN BY: TFWT	
CHECKED BY: ARM	
GMB FILE: 220133	
DATE: FEB 2022	

© COPYRIGHT 2021 GEORGE, MILES & BUHR, LLC

REVISIONS

REV #	DESCRIPTION	DATE
1		
2		
3		
4		
5		
6		
7		

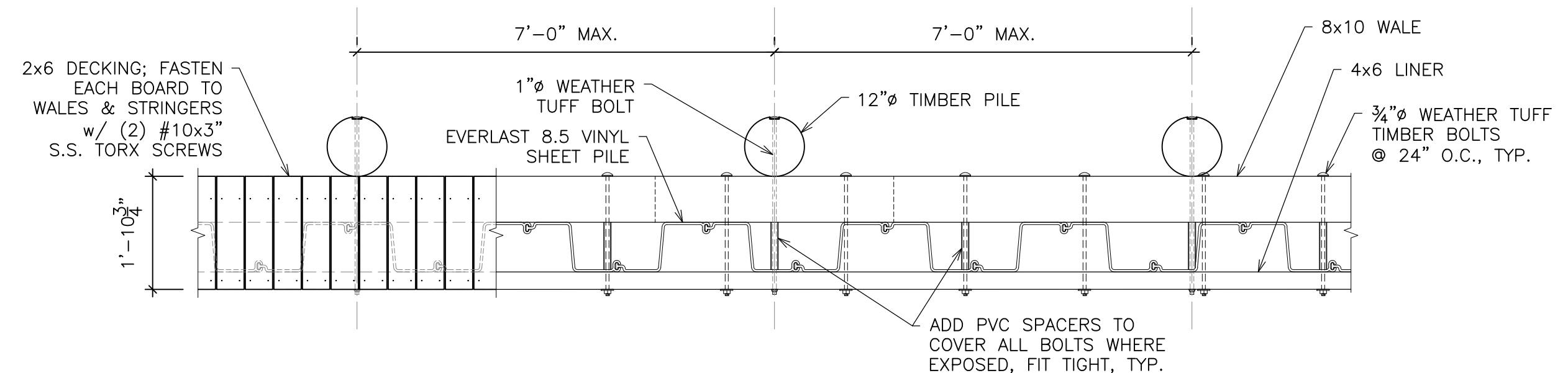
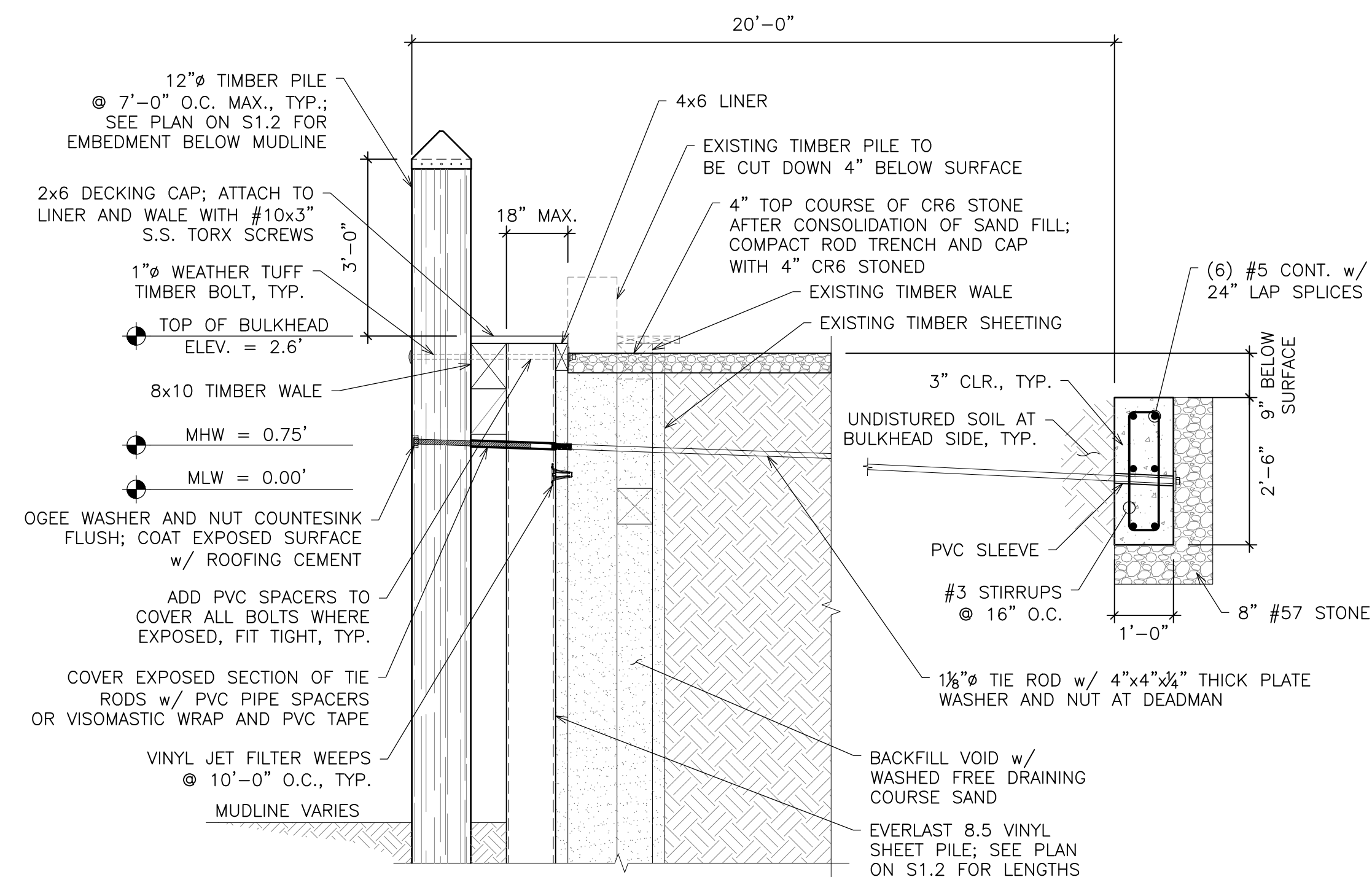

**TYPICAL BULKHEAD PLAN**  
SCALE: 1/2" = 1'-0"

**NOTE:**  
1) TIE RODS NOT SHOWN FOR CLARITY.

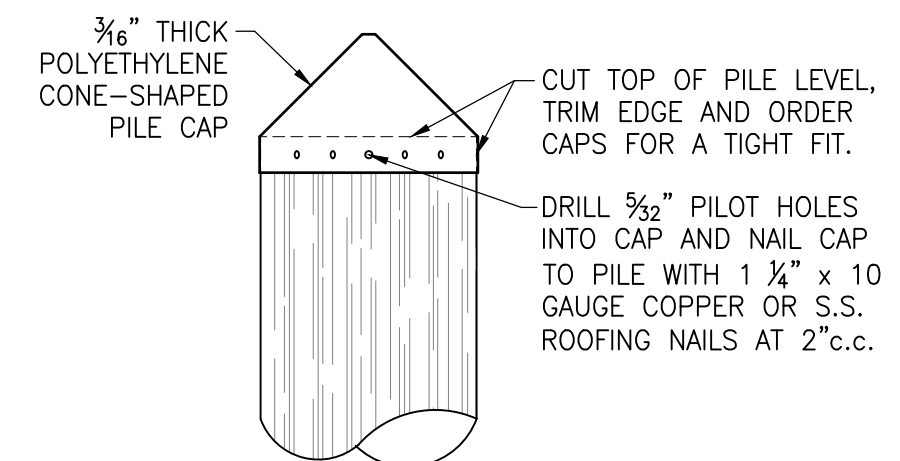
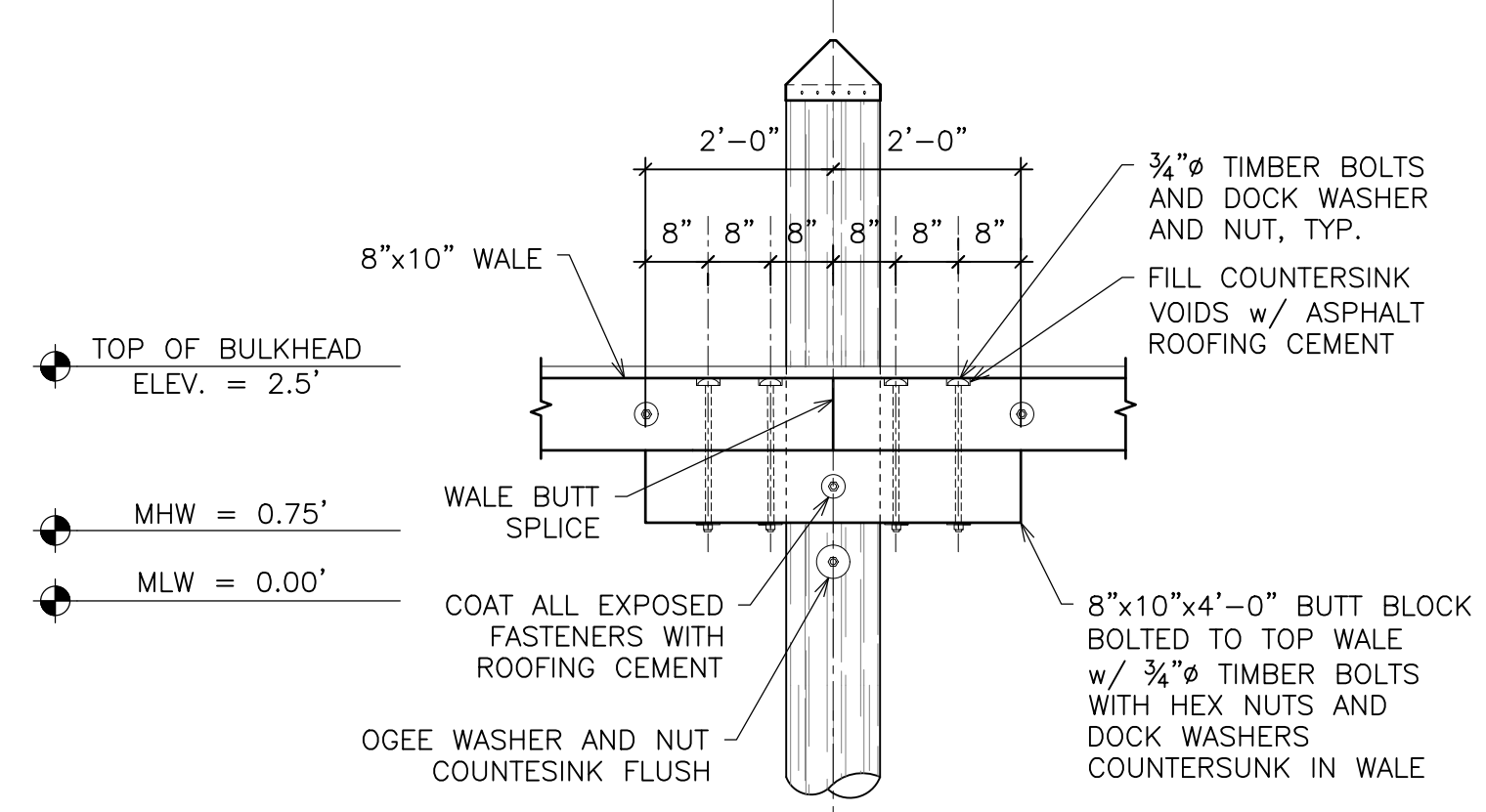

**PLASTIC CONE CAP OPTION**

**NOTE:**  
SHALL BE WHITE CONE CAPS

**TYP. PILE CAP DETAIL**  
N.T.S.

**STRUCTURAL NOTES**

- TIMBER PILES SHALL BE SOUTHERN PINE CONFORMING TO ASTM D-25, CLASS B WITH A 2.5 CCA RATING. PILES SHALL BE DRIVEN TO AN EMBEDMENT LENGTH OF 15.00' BELOW MUDLINE UNLESS NOTED OTHERWISE. DAMAGED PILES SHALL BE REMOVED AND REPLACED.
- ALL BOLTS SHALL BE DOME HEAD WEATHER-TUFF TIMBER BOLTS CONFORMING TO ASTM A307. ALL WASHERS U.N.O. SHALL BE 1/4" THICK N.Y.D.D. DOCK WASHERS AND NUTS SHALL BE HEAVY HEX TYPE UNLESS NOTED OTHERWISE. ALL NAILS SHALL BE STAINLESS STEEL RING SHANK OR ANNULAR NAILS AND IN ACCORDANCE WITH THE SIZES GIVEN IN THE CONTRACT DOCUMENTS. ALL HARDWARE SHALL BE HOT DIP GALVANIZED IN ACCORDANCE WITH ASTM A153, EXCEPT NAILS AND SCREWS, WHICH SHALL BE STAINLESS STEEL.
- ALL WALES TO BE SOUTHERN PINE, NO. 2 OR BETTER GRADE TREATED 2.5CCA. ALL DECKING BOARDS SHALL BE SOUTHERN PINE, NO.1 GRADE TREATED 0.15CA.
- USE FULL LENGTH VINYL CORNER PIECES FROM MANUFACTURER WHICH MATCH VINYL SHEETING PROFILES, TYPICAL ALL CORNERS AND BENDS.
- VINYL SHEETING SHALL BE EVERLAST (SEE PLAN FOR SIZE) OR APPROVED EQUIVALENT.
- CONCRETE (CAST-IN-PLACE) DESIGN AND DETAILING SHALL CONFIRM TO THE REQUIREMENTS OF ACI 318-19. CONTRACTOR SHALL SUBMIT MIX DESIGNS ACCOMPANIED BY APPROPRIATE GRAPHS AND BACKGROUND DATA FOR APPROVAL. MIX DESIGN SHALL INDICATE 7 AND 28 DAY STRENGTHS, CEMENT CONTENT, AIR CONTENT, WATER-CEMENT RATIO, AMOUNT OF FINE AND COARSE AGGREGATES, AND ADMIXTURES.
- MINIMUM COMPRESSIVE STRENGTH OF CONCRETE AT 28 DAYS SHALL BE AS FOLLOWS, UNLESS NOTED OTHERWISE.  
DEADMAN 3000 PSI
- IF NEEDED, DEWATERING SYSTEM MUST INCLUDE CODE COMPLIANT WATER FILTRATION AT DISCHARGE.
- THE GENERAL CONTRACTOR SHALL SUBMIT SHOP DRAWINGS AND/OR PRODUCT DATA SHEETS FOR ALL STRUCTURAL ELEMENTS SHOWN ON THE CONTRACT DOCUMENTS FOR APPROVAL. THE STRUCTURAL ENGINEER WILL NOT BE RESPONSIBLE FOR THE STRUCTURAL CERTIFICATION AND DESIGN OF THE PROJECT IF THE GENERAL CONTRACTOR FAILS TO OBTAIN APPROVAL OF THE SHOP DRAWINGS. THE GENERAL CONTRACTOR SHALL INFORM THE STRUCTURAL ENGINEER IN WRITING CONCERNING DEVIATIONS AND/OR OMISSIONS FROM THE CONTRACT DOCUMENTS AT THE TIME OF SHOP DRAWING SUBMISSION. THE GENERAL CONTRACTOR SHALL REVIEW ALL SHOP DRAWINGS AND SHALL MAKE ALL CORRECTIONS HE DEEMS NECESSARY BEFORE SUBMISSION. THE GENERAL CONTRACTOR SHALL STATE ON THE SHOP DRAWINGS THAT CONTRACT DOCUMENT REQUIREMENTS HAVE BEEN MET AND THAT ALL DIMENSIONS, CONDITIONS AND QUANTITIES HAVE BEEN REVIEWED AND VERIFIED AS SHOWN AND/OR CORRECTED ON THE SHOP DRAWINGS.

**GMB**  
GEORGE, MILES & BUHR, LLC  
ARCHITECTS & ENGINEERS  
SALISBURY • BALTIMORE • SEAFORD  
206 DOWNTOWN PLAZA  
SALISBURY, MARYLAND 21801  
410-742-3115; FAX 410-548-5790  
www.gmbnet.com

**SOUTHPOINT  
BULKHEAD REPLACEMENT  
WORCESTER COUNTY, MARYLAND**

**SECTIONS AND  
DETAILS**

SCALE: AS NOTED	SHEET NO.
DESIGN BY: ARM	<b>S2.1</b>
DRAWN BY: TFFT	
CHECKED BY: ARM	
GMB FILE: 220133	
DATE: FEB 2022	



# Maryland

## Department of the Environment

Larry Hogan, Governor  
Boyd K. Rutherford, Lt. Governor

Horacio Tablada, Secretary  
Suzanne E. Dorsey, Deputy Secretary

October 27, 2022

County Commissioners of Worcester County Maryland  
c/o George, Miles & Buhr, LLP  
Attention: Reggie Mariner  
206 W Main St  
Salisbury, Md 21801

Via email: rmariner@gmbnet.com

Re: Agency Interest Number: 71926  
Tracking Number: 202261641  
Tidal Authorization Number: 22-GL-1052

Dear County Commissioners of Worcester County Maryland:

Your application to alter tidal wetlands has been evaluated by the Tidal Wetlands Division. Your State wetlands license or permit authorizing work in tidal wetlands is attached. Please take a moment to read and review your authorization to ensure that you understand the limits of the authorized work and all of the general and special conditions.

Your project qualifies for federal approval under the Maryland State Programmatic General Permit (MDSPGP) under the Category A limits. The federal permit is not attached. The MDSPGP permit, general conditions, and activity specific special conditions must be downloaded from the Department's website at [https://mde.maryland.gov/programs/Water/WetlandsandWaterways/Pages/MDSPGP6\\_conditions.aspx](https://mde.maryland.gov/programs/Water/WetlandsandWaterways/Pages/MDSPGP6_conditions.aspx). You will need to download the following: Cover Letter, MDSPGP General Conditions, and the following MDSPGP-6 Activity-Specific Conditions (GP6) B3. You should not begin any work until you have obtained all necessary State, local, and federal authorizations.

This State authorization is a final agency decision; there is no further opportunity for administrative review. Any person with standing, who is either the applicant or who participated in the public participation process through the submission of written or oral comments, may petition for judicial review in the circuit court in the county where the authorized activity will occur. The petition for judicial review must be filed with the court within 30 days of receipt of this decision. Please contact Matt Godbey at [Matt.Godbey@maryland.gov](mailto:Matt.Godbey@maryland.gov) or 410-901-4033 with any questions.

Sincerely,

A handwritten signature in black ink, appearing to read "Jonathan Stewart".

Jonathan Stewart, Chief  
Eastern Region  
Tidal Wetlands Division



STATE OF MARYLAND  
DEPARTMENT OF THE ENVIRONMENT  
WATER AND SCIENCE ADMINISTRATION  
GENERAL TIDAL WETLANDS LICENSE



LICENSE NUMBER: **22-GL-1052**

EFFECTIVE DATE: **October 27, 2022**

EXPIRATION DATE: **October 26, 2025**

LICENSEE: **WO County Commissioners**

ADDRESS: **One West Market St, Rm 1103  
Snow Hill, MD 21863**

PROJECT LOCATION: **5820 South Point Rd**

**Berlin, MD 21811**

**Sinepuxent Bay in Worcester County**

PURSUANT TO THE AUTHORITY OF THE BOARD OF PUBLIC WORKS, TITLE 16 OF THE ENVIRONMENT ARTICLE, ANNOTATED CODE OF MARYLAND, AND CODE OF MARYLAND REGULATIONS 26.24 AND 23.02.04, County Commissioners of Worcester County Maryland (“LICENSEE”) IS AUTHORIZED BY THE WATER AND SCIENCE ADMINISTRATION (“ADMINISTRATION”) TO CONDUCT THE FOLLOWING REGULATED ACTIVITY IN STATE TIDAL WETLANDS, IN ACCORDANCE WITH THE CONDITIONS OF THIS LICENSE AND THE ATTACHED PLANS DATED September 13, 2022 PREPARED BY George, Miles & Buhr, LLP, AND APPROVED BY THE ADMINISTRATION’S TIDAL WETLANDS DIVISION ON October 27, 2022, AND INCORPORATED HEREIN:

*Construct and backfill 550 linear feet of replacement vinyl bulkhead within a maximum of 18 inches channelward of a deteriorated bulkhead.*

## SPECIAL CONDITIONS

- A. The Licensee shall complete construction of the bulkhead prior to filling behind the bulkhead. The bulkhead shall be designed and constructed to prevent the loss of fill material to waters of the State of Maryland. Only clean fill, which is free of organic, toxic, contaminated, or deleterious materials, shall be used.

## GENERAL CONDITIONS

- A. The Maryland Department of the Environment has determined that the proposed activities comply with, and will be conducted in a manner consistent with the State’s Coastal Zone Management Program, as required by Section 307 of the Federal Coastal Zone Management Act of 1972, as amended.
- B. The Licensee shall comply with all Critical Area requirements and obtain all necessary authorizations from local jurisdiction. This License does not constitute authorization for disturbance in the 100-foot Critical Area Buffer. “Disturbance” in the Buffer means clearing, grading, construction activities, or removal of any size of tree or vegetation. Any anticipated Buffer disturbance requires prior written approval, before commencement of land disturbing activity, from local jurisdiction in the form of a Buffer Management Plan.



- C. If the authorized work is not performed by the property owner, all work performed under this Tidal Wetlands License shall be conducted by a marine contractor licensed by the Marine Contractors Licensing Board (MCLB) in accordance with Title 17 of the Environment Article of Annotated Code of Maryland. A list of licensed marine contractors may be obtained by contacting the MCLB at 410-537- 3249, by e-mail at [MDE.MCLB@maryland.gov](mailto:MDE.MCLB@maryland.gov) or by accessing the Maryland Department of the Environment, Environmental Boards webpage.
- D. The Licensee certifies real property interest in the contiguous upland.
- E. The issuance of this permit is not a validation or authorization by the Department for any of the existing structures depicted on the plan sheets on the subject property that is not part of the authorized work description, nor does it relieve the Licensee of the obligation to resolve any existing noncompliant structures and activities within tidal wetlands.
- F. This License does not authorize any existing structures depicted on the plan sheets that are not specifically described in the description of work.
- G. The Licensee acknowledges that this authorization is based on current water depths that are existing and indicated on the attached plan sheet. This License proposes no dredging and this license provides no justification or assurances for future dredging. All dredging projects will be evaluated on the biological and physical characteristics of the site at the time an application is made.
- H. The Licensee shall obtain an approved sediment and erosion control plan from the local soil conservation district when the area disturbed is greater than 5000 square feet or 100 cubic yards of fill.
- I. The Licensee shall ensure that a copy of this License, including the approved plans, is available at the site until the authorized work is complete.
- J. The Licensee shall make every reasonable effort to design and construct the structure or perform the activity authorized in this License in a manner which minimizes adverse impacts on natural resource values, including water quality, plants, wildlife, plant and wildlife habitat, and on historic property values.
- K. The Secretary of the Environment may suspend or revoke a License if the Secretary finds that the Licensee has not complied with any condition or limitation in the License or has exceeded the scope of the authorized activities.
- L. The Licensee shall indemnify, defend and hold harmless the State of Maryland, its officials, officers, and employees from and against any and all liability, suits, claims and actions of whatever kind, caused by or arising from the work authorized by the License.
- M. The Licensee acknowledges that this License does not transfer any property interest in State tidal wetlands. This License allows the Licensee to use State tidal wetlands only for the structure or activity authorized herein and in no way limits the use of waters of the State by the public.
- N. This License is valid only for use by the Licensee. Permission for transfer of the License shall be obtained from the Water and Science Administration, Tidal Wetland Division. The terms and conditions of this License shall be binding on any assignee or successor in interest of the License.

- O. The Licensee shall allow representatives of the Maryland Department of the Environment to inspect the authorized activities.
- P. The Licensee shall notify the Maryland Department of the Environment, Water and Science Administration, Compliance Program at least 10 days before starting the authorized activities at (410) 901-4020.
- Q. The Licensee shall complete construction of the activity authorized under this License by the expiration date, otherwise a new General License shall be obtained.
- R. Upon completion of the authorized activities, the Licensee shall notify the Maryland Department of the Environment, Water and Science Administration, Compliance Program at (410) 901-4020.

By authority of the Secretary of the Environment:



11/1/2022

---

Heather L. Nelson, Program Manager  
Wetlands and Waterways Protection Program

---

Date

Tidal Wetland Reviewer: *Matt Godbey*

Supervisor Concurrence: *SS*

Tracking Number: 202261641

Agency Interest Number: 71926

Enclosure: Plans dated **September 13, 2022**

cc: WSA Inspection & Compliance Program

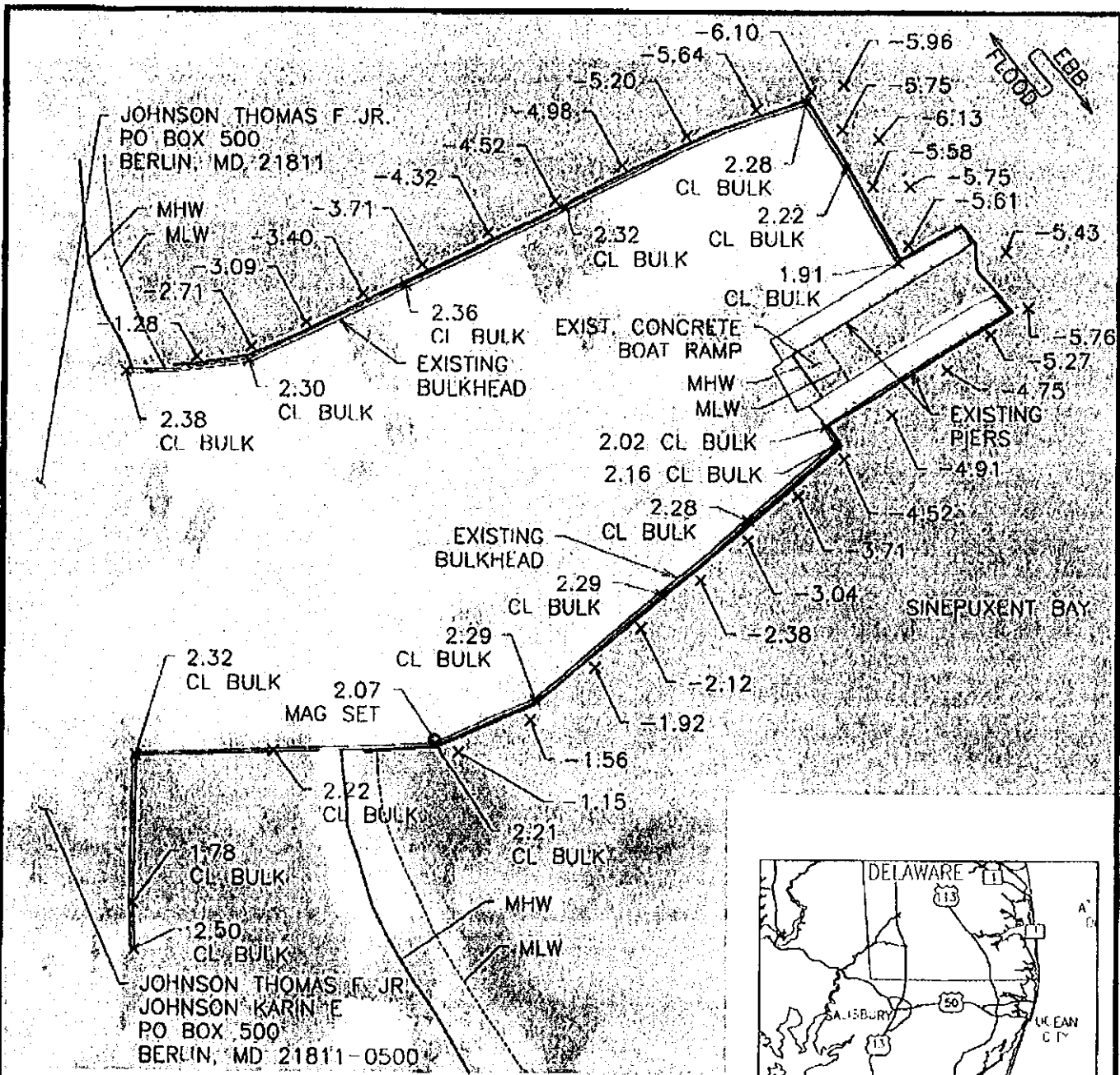

**EXISTING SITE PLAN**

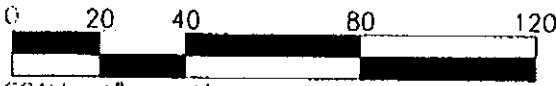

SCALE: 1" = 40'

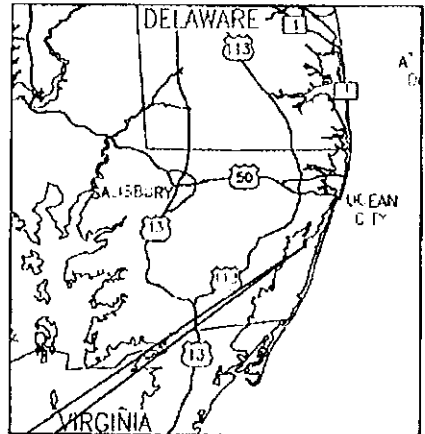

**VICINITY MAP**  
N.T.S.

PROJECT AREA

DRAWN BY: JFV  
CK. BY: ARM  
JOB NO.: 220133  
SCALE: AS NOTED  
DATE: AUG 2022

**GMB**  
GEORGE, MILES & BUHR, LLC  
ARCHITECTS & ENGINEERS  
SALISBURY - BALTIMORE - SEAFORD  
www.gmbnet.com

**SOUTH POINT  
BULKHEAD REPLACEMENT  
WORCESTER COUNTY, MD**

**1**

22-GL-1052  
202261641  
71926  
9/13/2022  
MG

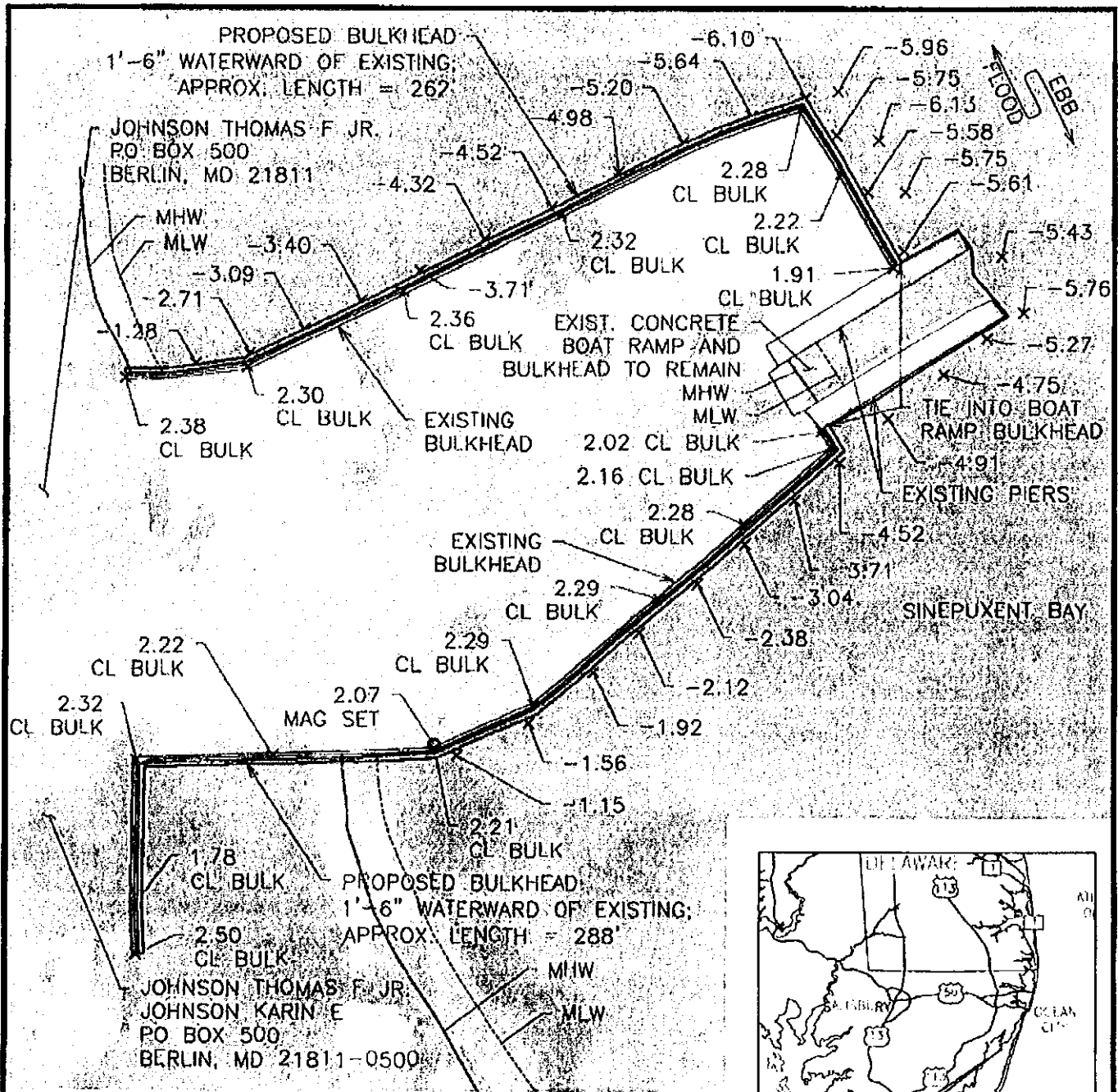

**PROPOSED SITE PLAN**



SCALE: 1" = 40'

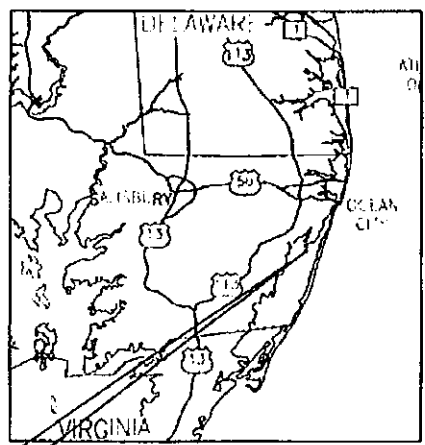

**VICINITY MAP**  
N.T.S.

PROJECT AREA

DRAWN BY: TTVT  
 CK. BY: ARM  
 JOB NO.: 220133  
 SCALE: AS NOTED  
 DATE: AUG 2022

**GMB**  
 GEORGE, MIES & BUHR, L.C.  
 ARCHITECTS & ENGINEERS  
 SALISBURY • BALTIMORE • SEAFORD  
 www.gmbnet.com

**SOUTH POINT  
 BULKHEAD REPLACEMENT  
 WORCESTER COUNTY, MD**

**2**

22-GL-1052  
 202261641  
 71926  
 9/13/2022  
 MG

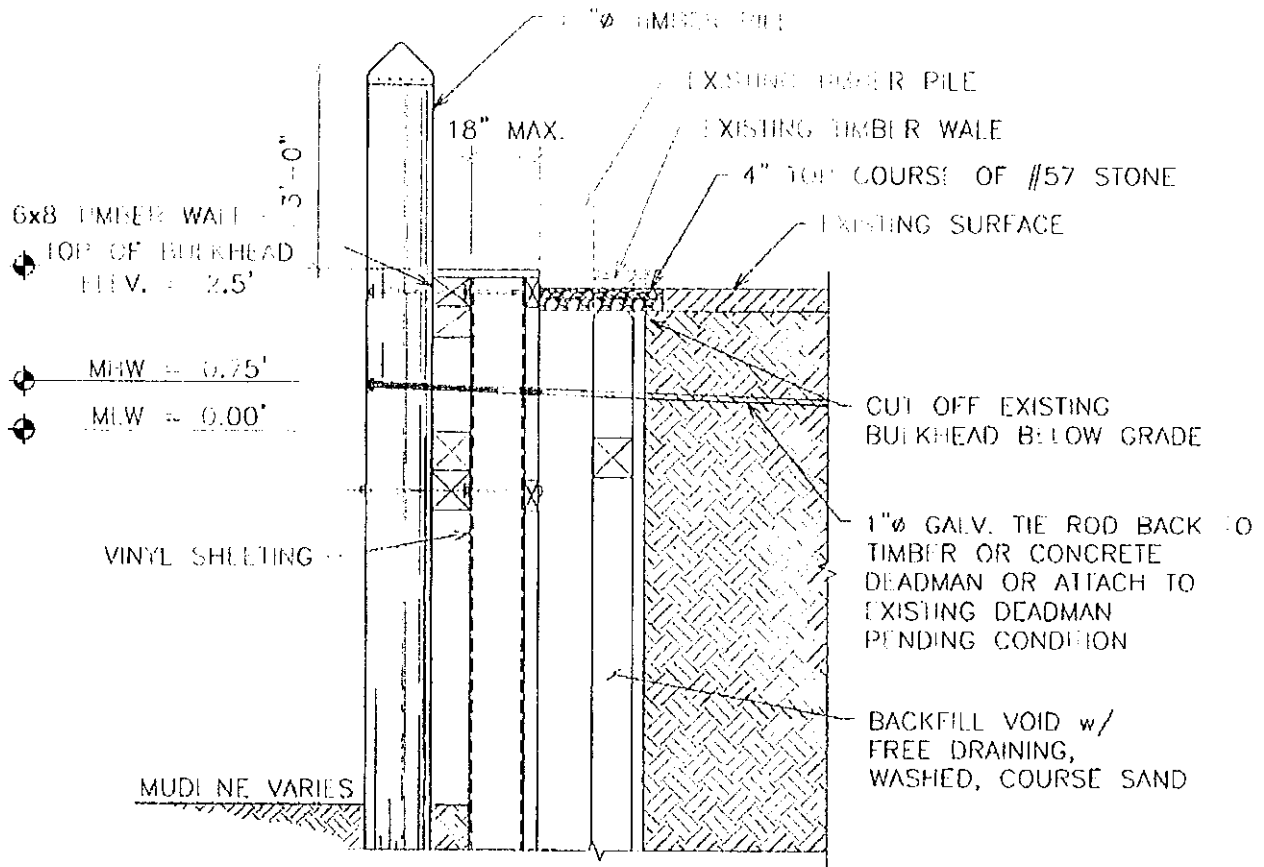

## PROPOSED BULKHEAD SECTION

SCALE:  $\frac{3}{8}" = 1' 0"$

DRAWN BY: TCVT

CK. BY: ARM

JOB NO.: 220133

SCALE: AS NOTED

DATE: AUG 2022

**GMB**

GEORGE, MILES & BUHR, LLC  
ARCHITECTS & ENGINEERS  
BALTIMORE • BALTIMORE • SEAFORD  
www.gmbnet.com

**SOUTH POINT  
BULKHEAD REPLACEMENT**

**WORCESTER COUNTY, MD**

**3**

